

# EZRUN

## USER MANUAL

Sensorless Brushless Motor  
EZRUN 3652/3660 G2



Thank you for purchasing the EZRUN 3652/3660 G2, HOBBYWING's high performance sensorless brushless motor! Brushless power systems can be very dangerous, any improper use may cause personal injury and damage to the product and related devices.



We strongly recommend reading through this user manual before use. Because we have no control over the use, installation, or maintenance of this product, no liability may be assumed for any damages or losses resulting from the use of this product. We do not assume responsibility for any losses caused by unauthorized modifications to our product.

## 01 Warnings



- Never leave this product unsupervised when it is powered on.
- Ensure all wires and connections are well insulated before connecting the motor to related devices, as short circuit will damage your motor.
- Read through the manuals of all power devices and chassis and ensure the power configuration is rational before using this unit.
- Never hit full throttle before installing the pinion, as high speed rotation may cause damage to the motor in circumstances of no load.
- Ensure all devices are well connected, in order to prevent poor connection that may cause your vehicle to lose control or other unpredictable issues such as damage to the device.
- Stop using the motor when its shell temperature exceeds 100 C/212 F; otherwise the rotor may be demagnetized and cause irreversible damage to your motor.

## 02 Features

- Innovative 4-pole-8-magnet "staggered pole" rotor (Hobbywing-patented) with low cogging effect and torque pulsation greatly improves control feel around corners.
- Built-in temperature sensor and sensor port protect the motor from damage due to overheat when pairing EZRUN 3652/3660 G2 with a EZRUN MAX10/MAX10 SCT ESC.
- O-ring seal fitted between the front end bell and motor case isolates screw holes from inner parts to prevent liquid or dust from getting inside and protect motor from damage.
- Special design implemented by the motor case (the end attaches to the front end bell) isolates inner coils from outside to protect winding from being damaged by overlong screws.
- Special technology for temperature control implemented by this motor guarantees less heat more efficiency (efficiency rate of up to 90%).
- CNC machined aluminum housing, high purity copper windings, advanced rotor structure, high-quality alloy steel output shaft, high-precision bearings for high durability and smoothness.
- Rebuild-able design (partially rebuild-able) for routine maintenance effectively prolongs the motor life and raises the motor efficiency.
- Excellent match between EZRUN 3652/3660 G2 with EZRUN MAX10/MAX10 SCT guarantees users large torque plus a very smooth and linear power band.

## 03 Specifications

Model	PN	KV (No-load)	LiPo	R. (Ω)	No-load Current	Motor Diameter & Length	Shaft Diameter & Length	Poles	W (g)	Applications
EZRUN-3652SL-3300KV-G2	30402600	3300	2-3S	0.0100	4.3A	Φ=36 / L=52	Φ=3.175 / L=15	4	218	1:10 Scale Touring Car/Buggy(Sport)
EZRUN-3652SL-4000KV-G2	30402601	4000	2-3S	0.0074	5.2A				216	1:10 Scale SCT (2WD)
EZRUN-3652SL-5400KV-G2	30402602	5400	2S	0.0051	7.2A				217	1:10 Scale Monster Truck/Truck (Light-duty)
EZRUN-3660SL-3200KV-G2	30402650	3200	2-3S	0.0083	4.9A	Φ=36 / L=60	Φ=5 / L=18.5		262	1:10 Scale SCT (4WD)
EZRUN-3660SL-4000KV-G2	30402651	4000	2-3S	0.0060	5.7A				268	1:10 Scale Monster Truck/Truck (Heavy-duty)
EZRUN-3660SL-4600KV-G2	30402652	4600	2S	0.0053	7.2A				262	

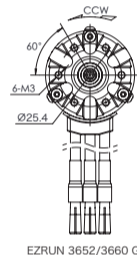
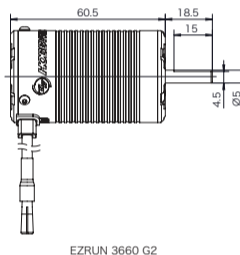
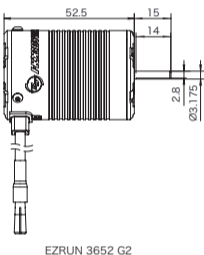
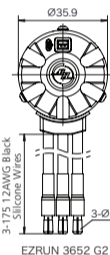
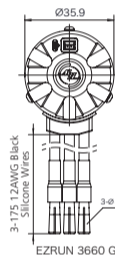

## 04 Installation & Connection

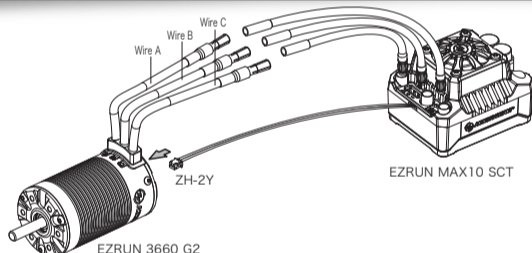

### 1. How to Mount the Motor into a RC vehicle

M3 mounting screws (6\*M3) are needed here, as the mounting holes are 5mm in depth, so we don't recommend using the M3 screws with the length exceeds 8mm to mount the motor into your vehicle.

### 2. How to Connect the Motor to an ESC

There is no polarity on the A/B/C three ESC-to-motor wires, so do not worry about how you connect them initially. You may find it necessary to swap two wires if the motor runs in reverse. When pairing with a HOBBYWING EZRUN MAX10/MAX10-SCT ESC, plug the ZH-2Y male connector on the ESC into the TEMP port at the load end of the motor can make the motor thermal protection available.

### 3. Recheck the Installation & Connections

Recheck the installation and all the connections before turning on the power.

## 05 FDR/Gear Ratio Selection

It's important to select the FDR/gear ratio properly, as improper FDR/gear ratio may cause you great loss. Therefore, please choose the gear ratio by referring to the following points!

### 1. Operating Temperature of the Motor

The motor temperature should be lower than 100°C (212°F) during the operation. Temperatures above 100°C will weaken the magnet and may partly melt the coils and eventually damage the ESC (because of strong current). Therefore, the most effective way to prevent overheat is to select the right gear ratio.

**Note:** We recommend enabling the Motor Thermal Protection (on the ESC) when you are pairing the motor with a HOBBYWING EZRUN MAX10/MAX10-SCT ESC.

### 2. Principle of Gear Ratio Selection

To avoid potential risks such as ESC/motor damage or malfunction caused by overheat, please start with a very small pinion first and check the ESC & motor temperatures regularly throughout the run. This is the only way to guarantee that your motor won't overheat. If the motor and ESC temperatures remain stable and low in the running, then you can slowly increase the pinion size while monitoring temperatures to determine the safe gearing for your vehicle, climate and track condition. Because these elements may change, so please keep monitoring the ESC & motor temperatures to protect your electronics from damage.

## 06 Assembly/Disassembly

For prolonging the motor life and raising its efficiency, we recommend checking and cleaning the motor regularly. About the frequency, it depends on the times you use the motor and the track condition. Please refer to the following diagrams to assemble your motor and dismantle it in the reverse order if necessary.

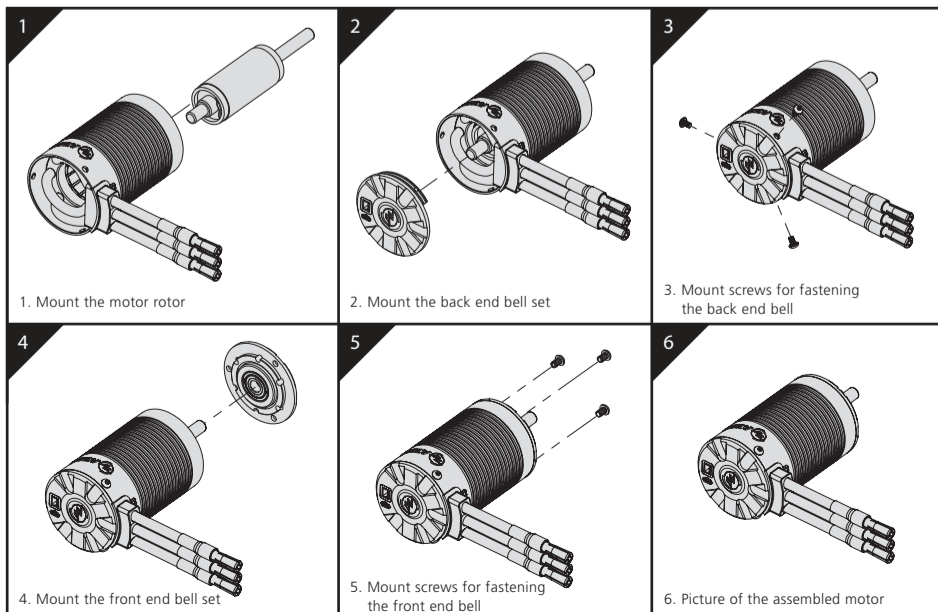

### Parts List

